

# Der LASCO Heubagger

**LASCO**  
Heutechnik GmbH



LASCO Heutechnik GmbH  
Scherschham 14  
A-5221 Lochen (nähe Salzburg)  
Telefon: +43 (0)7745 / 8613-0  
Fax: +43 (0)7745 / 8613-4  
E-Mail: [office@lasco.at](mailto:office@lasco.at)  
Web: [www.lasco.at](http://www.lasco.at)







































Flyer 2015 / Auflage 1: Änderungen, Irrtümer sowie Druck- und Satzfehler vorbehalten. Bilder und Zeichnungen schematisch.

Technische Änderungen im Sinne der Weiterentwicklung vorbehalten.

# Typen und Serienausstattung

2-Rad Ausführung / MB 2			4-Rad Ausführung / MB 4		
Type	Tele	Reichweite	Type	Tele	Reichweite
MB 2K-71-T3	3	7,10m	MB 4K-71-T3	3	7,10m
MB 2K-79-T3	3	7,9m	MB 2K-79-T3	3	7,90m
MB 2K-83-T2	2	8,30m	MB 4K-83-T2	2	8,30m
MB 2L-91-T2	2	9,10m	MB 4L-91-T2	2	9,10m
MB 2K-105-T3	3	10,5m	MB 4K-105-T3	3	10,5m
MB 2L-113-T3	3	11,3m	MB 4L-113-T3	3	11,3m

Reichweiten: Mitte Drehkran bis Mitte Gabel.

Serienausstattung	MB2	MB4
<b>Komfort</b>		
Automatischer Stern-Dreieckanlauf		
230 V Steckdose		
Komfortestieg		
Design-Kabine mit LED-Scheinwerfer und Wetterschutzdach		
Stundenzähler		
Elektrisch proportionale Vorsteuerung		
<b>Technik</b>		
6-Kant-Auslegersystem (vollhydraulisch)		
Doppelwandige Hydraulikschläuche		
Getriebeschwenkmotor mit Bremse		
7,5 kW Elektromotor		
2-Kreis-Hydrauliksystem		
Motor gekapselt unter dem Sitz		
Groß dimensionierte Hydraulikleitungen		
Geschraubter Hydrauliktank mit Filter (ca. 60 Liter)		
Antriebsmotoren mit Planetengetriebe in gebremster Ausführung		
Greifer 750mm mit Zylinder und 6 Zinken		
Drehbereich 700°		
2-Hubzylinder (80mm°)		
gehärteter Kugeldrehkranz D700mm		
Beton-Ballastgewicht		

Zusatzausstattung	MB2	MB4
<b>Technik</b>		
Elektromotor 9,2 kW	⬢	⬢
Balastgewicht Wassertank	⬢	⬢
Pendelachse		⬢
Deichsel	⬢	⬢
Kabelaufroller mit 15m Kabel	⬢	⬢
Zapwellenaggregat	⬢	⬢
Diesellaggregat mit Batterie und Starteinrichtung		⬢
geschlossene Kabine mit Radio, Heizung und Klimaanlage		⬢
Bereifung Flotation 400/60-15.5	⬢	⬢
Kabine höhenverstellbar (ca. 1,5m)	⬢	⬢
Ölkühler	⬢	⬢
4-Rad-Lenkung	⬢	⬢
Allradausführung	⬢	⬢
<b>Auslegerzuberhör</b>		
Heugreifer / Einsteckteile auf 1400mm	⬢	⬢
Greiferhochstellung & Rotator	⬢	⬢
Holzanglen / Zweischalengreifer / Mistgreifer	⬢	⬢

Die angeführte Zusatzausstattung stellt lediglich einen Überblick da und ist nicht vollständig. Abmessungen in mm.

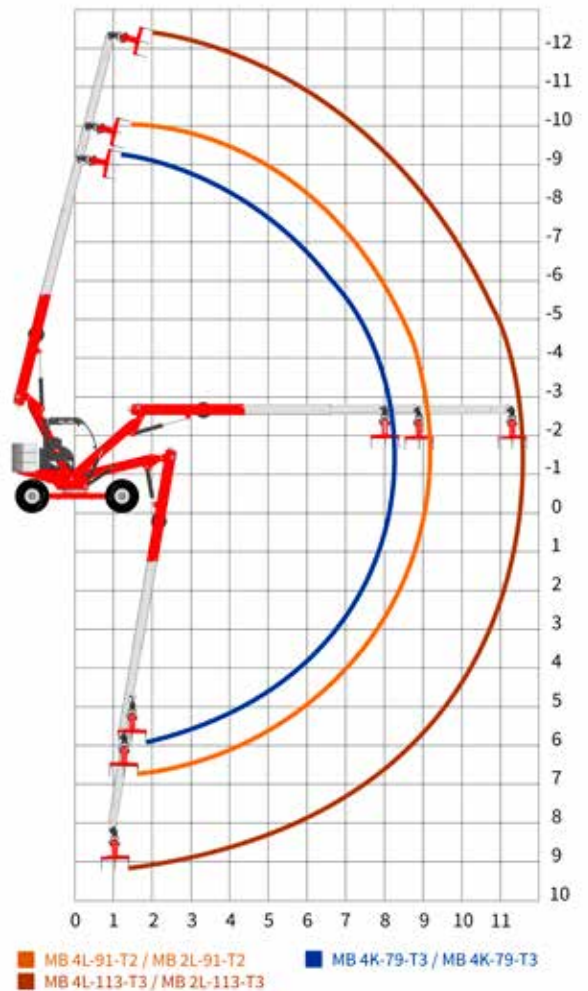
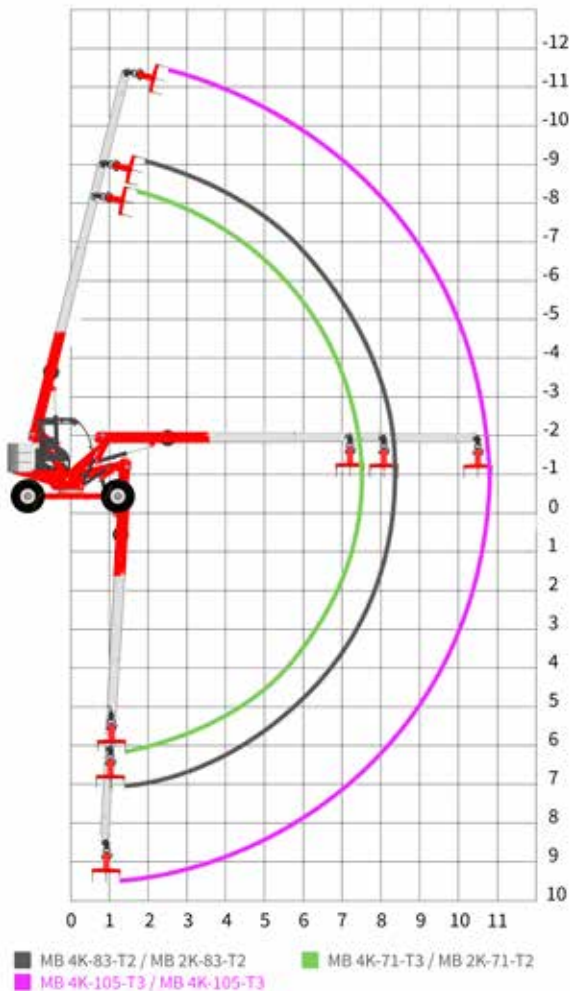

# Abmessungen

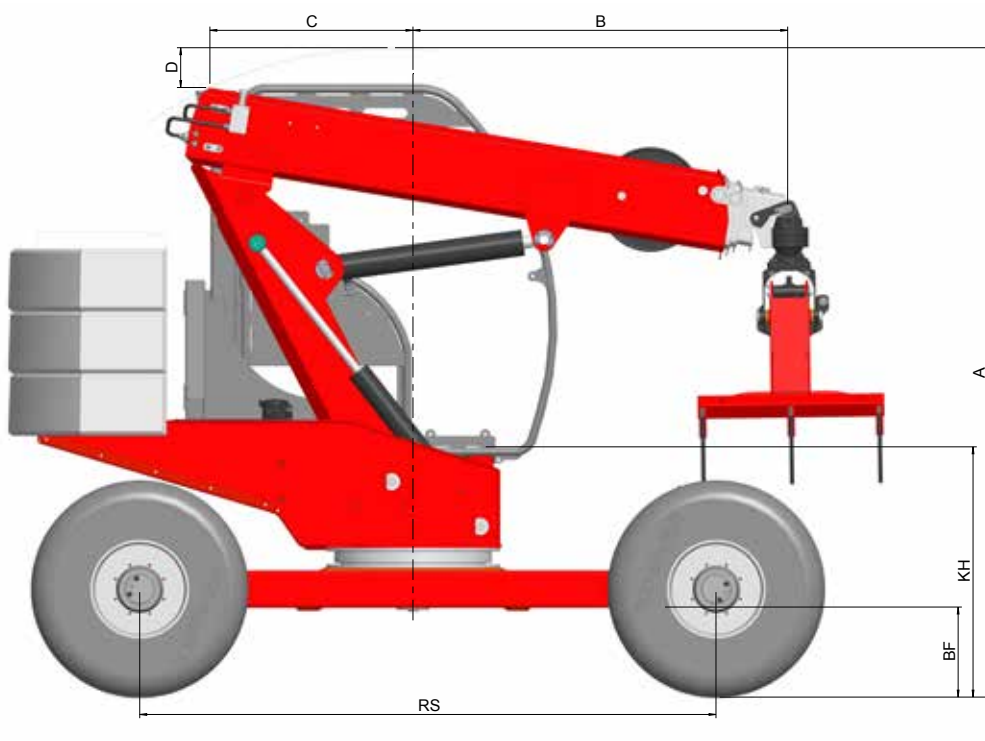

Radstand (RS)	2320
Kabinenhöhe	1008
Wenderadius (WR)	2722
Schwenkradius (SR)	1630
Bodenfreiheit (BF)	362

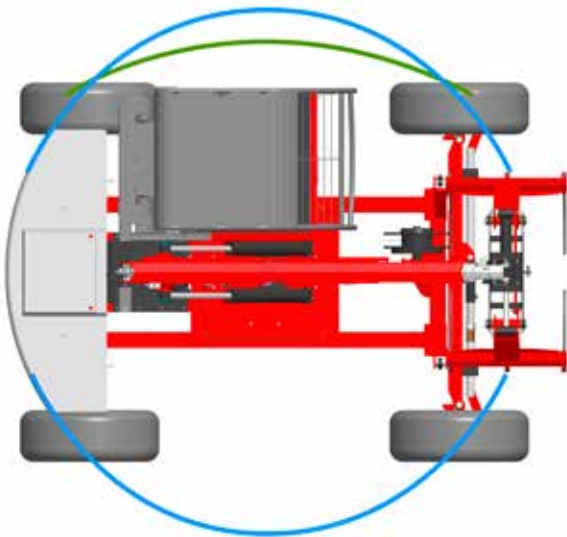

Type	A	B	C	D
MB4K-71-T3	2615	1508	817	160
MB4K-79-T3	3698	1508	1312	279
MB4K-83-T2	2602	2311	810	137
MB4L-91-T2	3687	1814	1307	257
MB4K-105-T3	2612	2341	815	157
MB4L-113-T3	3697	1844	1312	277



■ Wenderadius (2722mm) ■ Schwenkradius (1630mm)

